

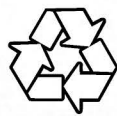

FORTRESS



Printed in EU



WARNING: CHOKING HAZARD-
Toy contains small parts.
Not for children under 3 years.

1

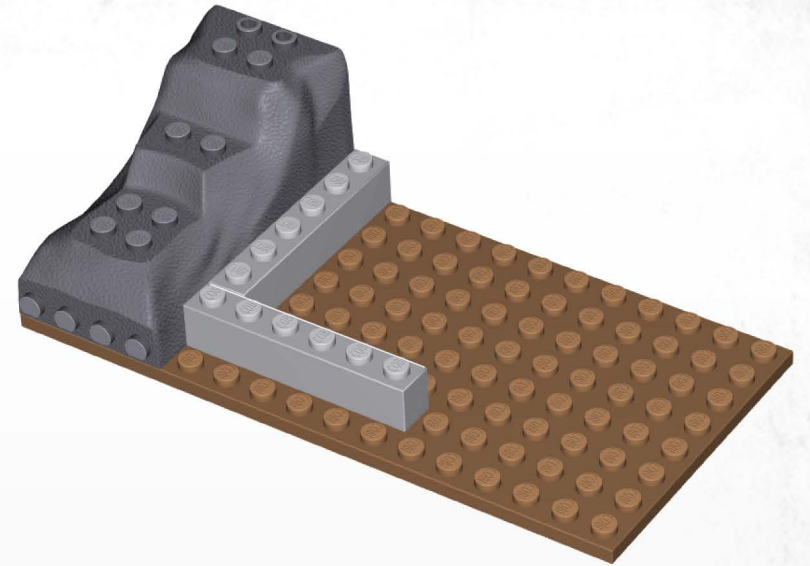
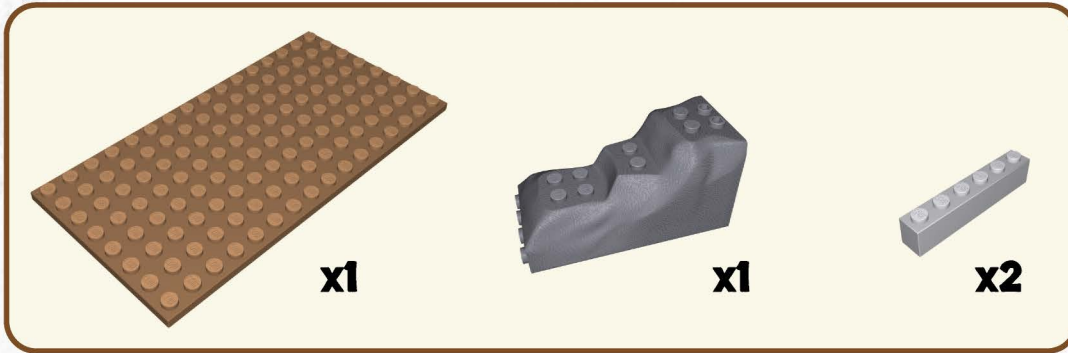



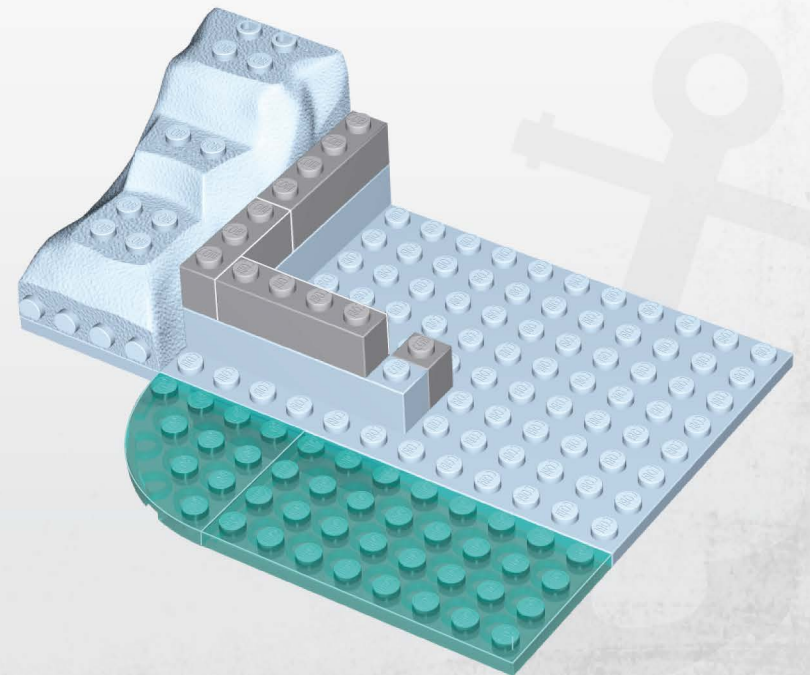
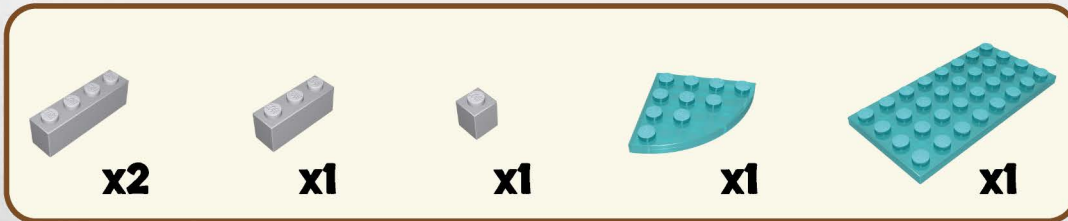

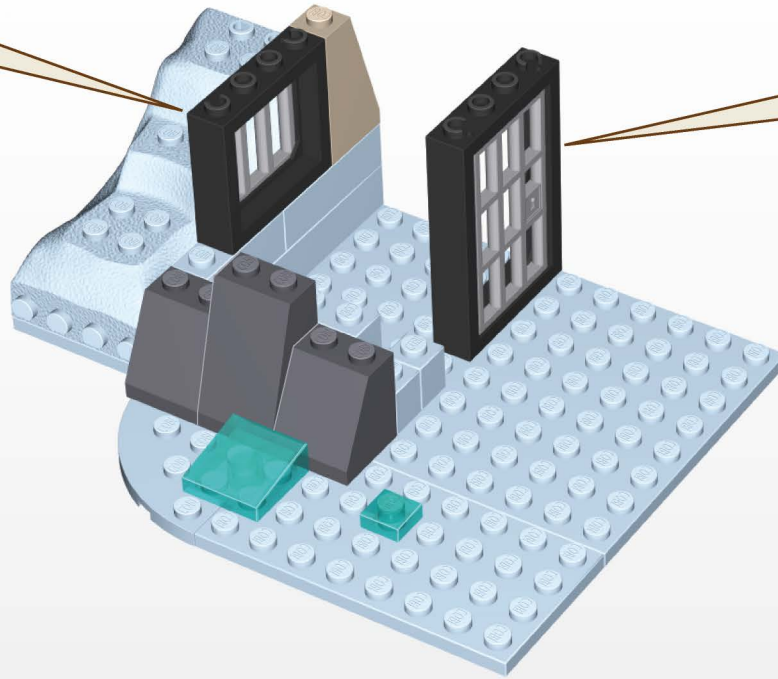
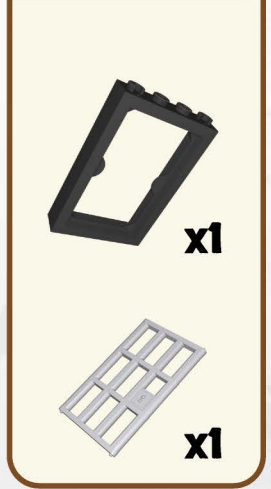
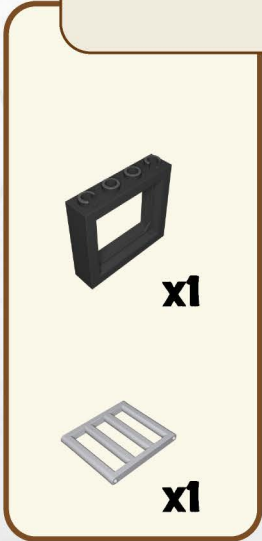
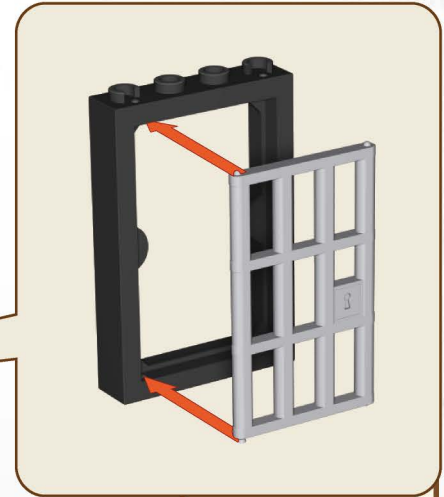
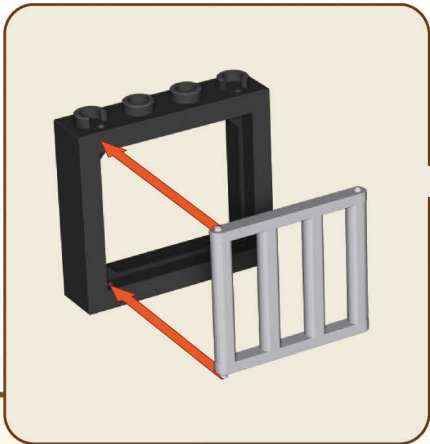



2





BE CAREFUL: NOTICE THE DIFFERENCE

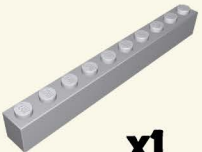

-  **x2**
-  **x1**
-  **x1**
-  **x2**
-  **x3**
-  **x1**
-  **x1**
-  **x1**
-  **x1**

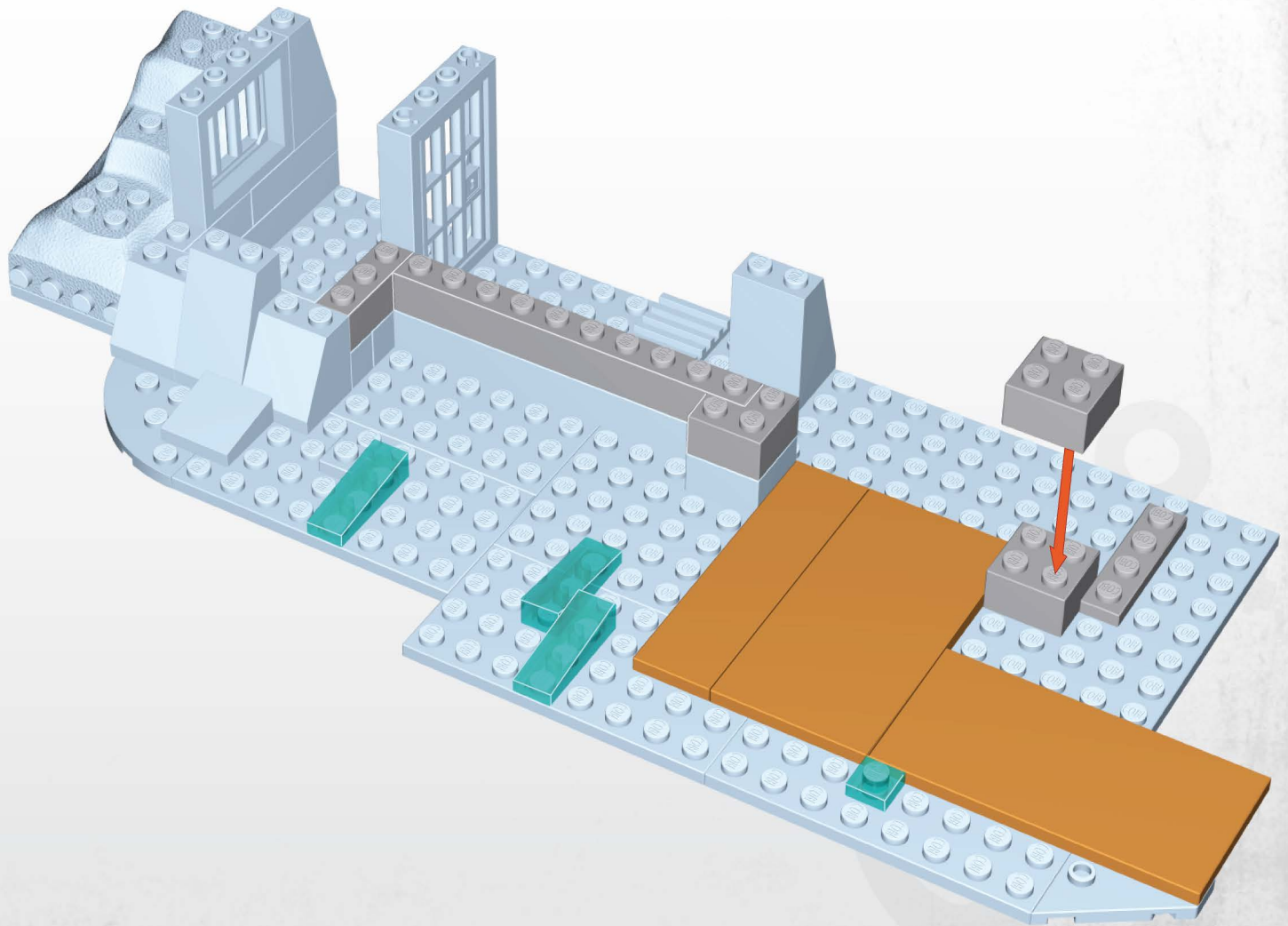



x1



x2



x1



x1



x1



x1



x1



x1







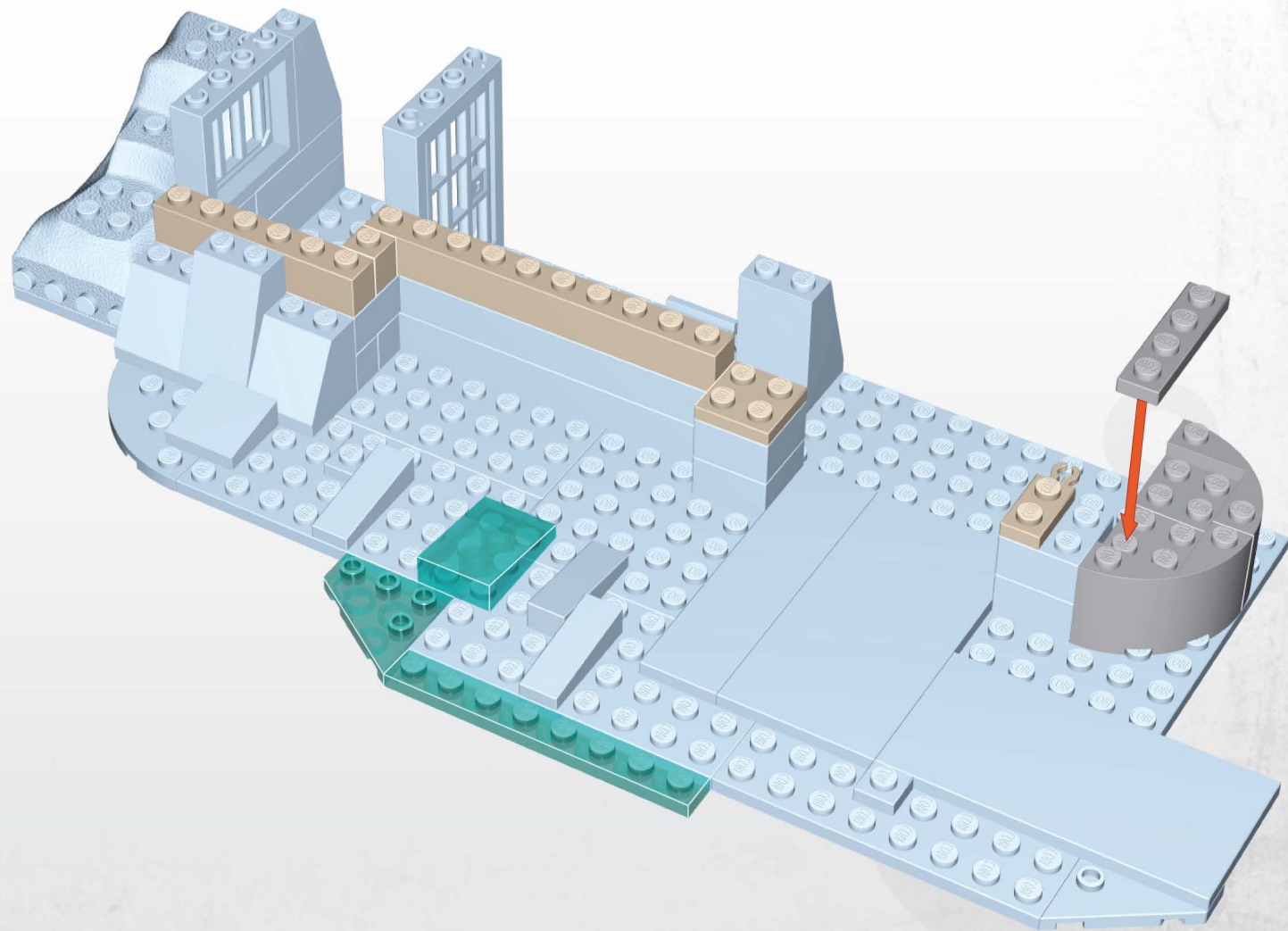

x1





x1

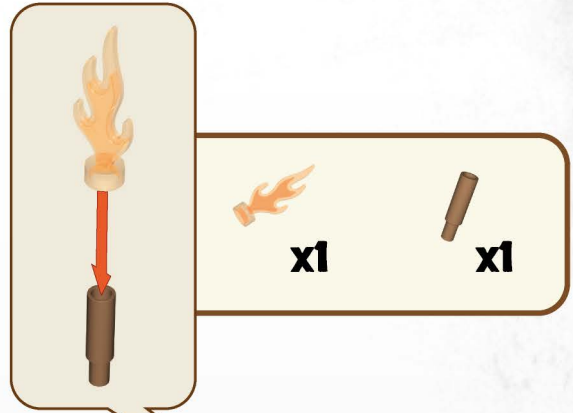

-  x1
-  x1
-  x1
-  x1
-  x1
-  x1
-  x1



 x1

 x1

This callout shows a brown torch handle with an orange flame on top. A red arrow points from the handle to the main assembly, indicating where it should be placed.

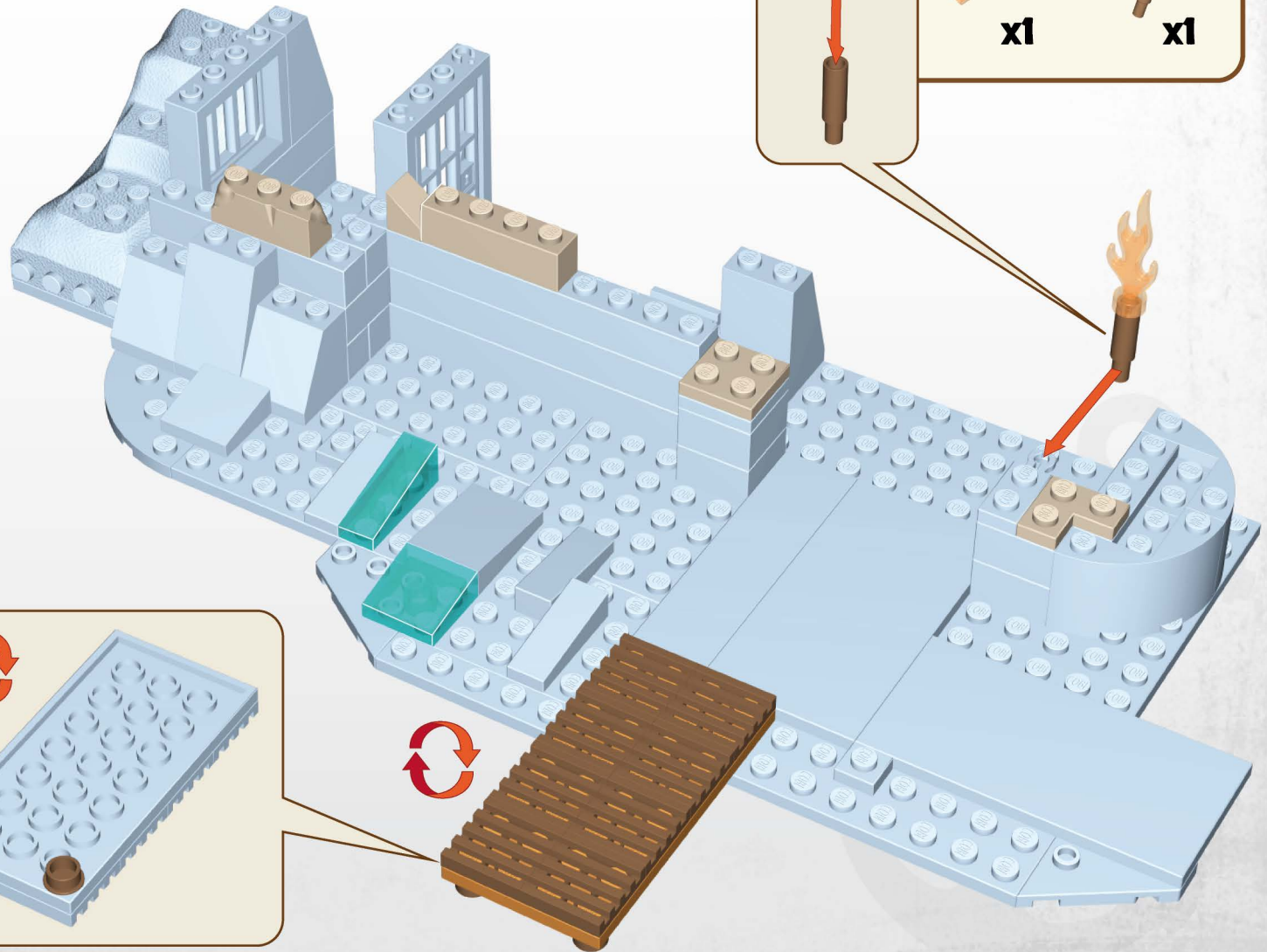



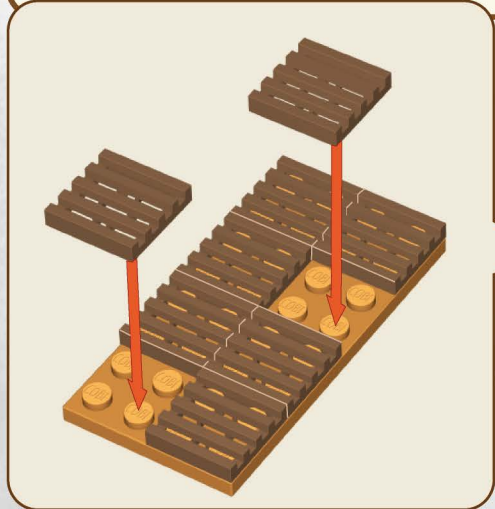



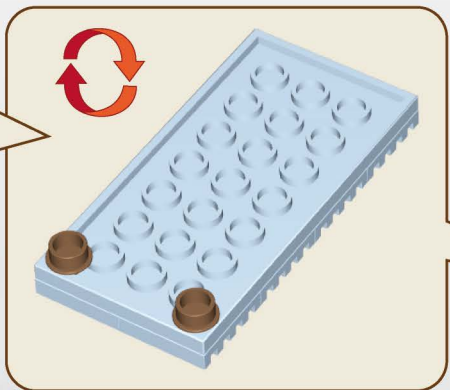

-  x1
-  x8
-  x2







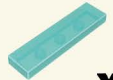

This callout shows two brown 1x8 Technic plates being placed on a brown 1x10 plate. Red arrows indicate the placement of the plates.

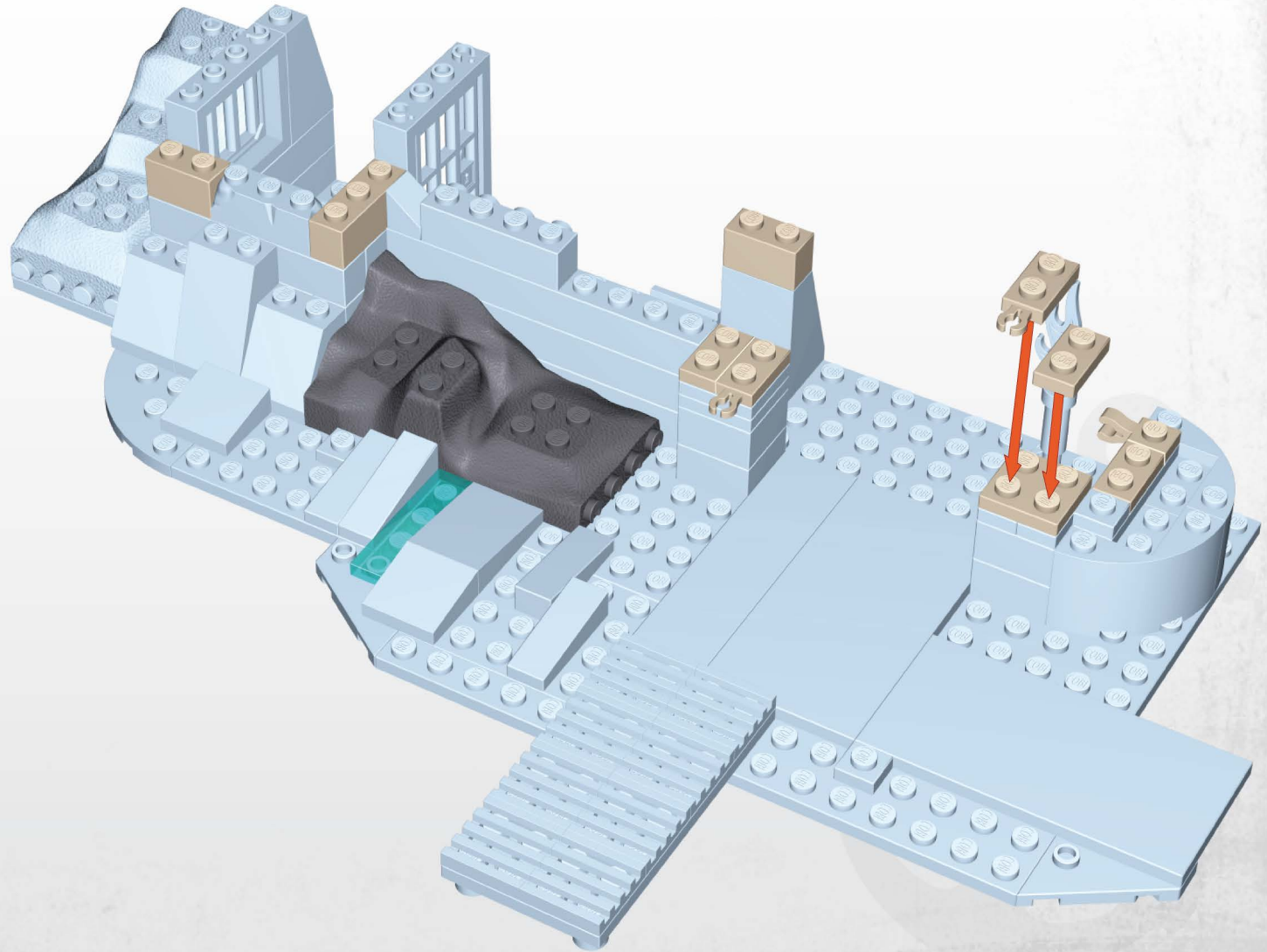







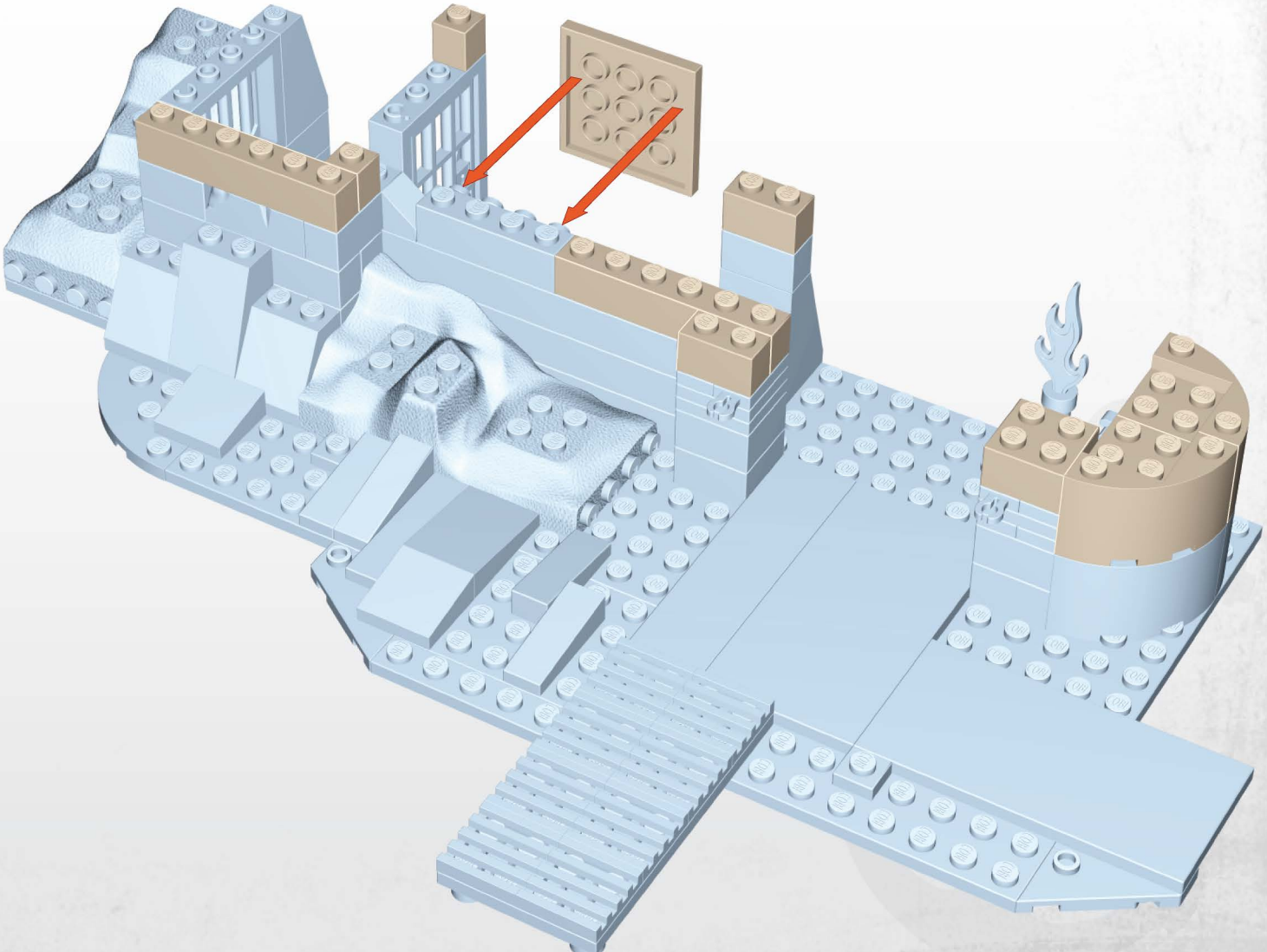

This callout shows a light blue 1x10 plate with two brown 1x1 pins inserted into the holes. A red double-headed arrow indicates a reversible step.

-  x1
-  x2
-  x3
-  x1
-  x1
-  x2
-  x1
-  x1
-  x1





-  **x2**
-  **x2**
-  **x2**
-  **x1**
-  **x1**
-  **x2**



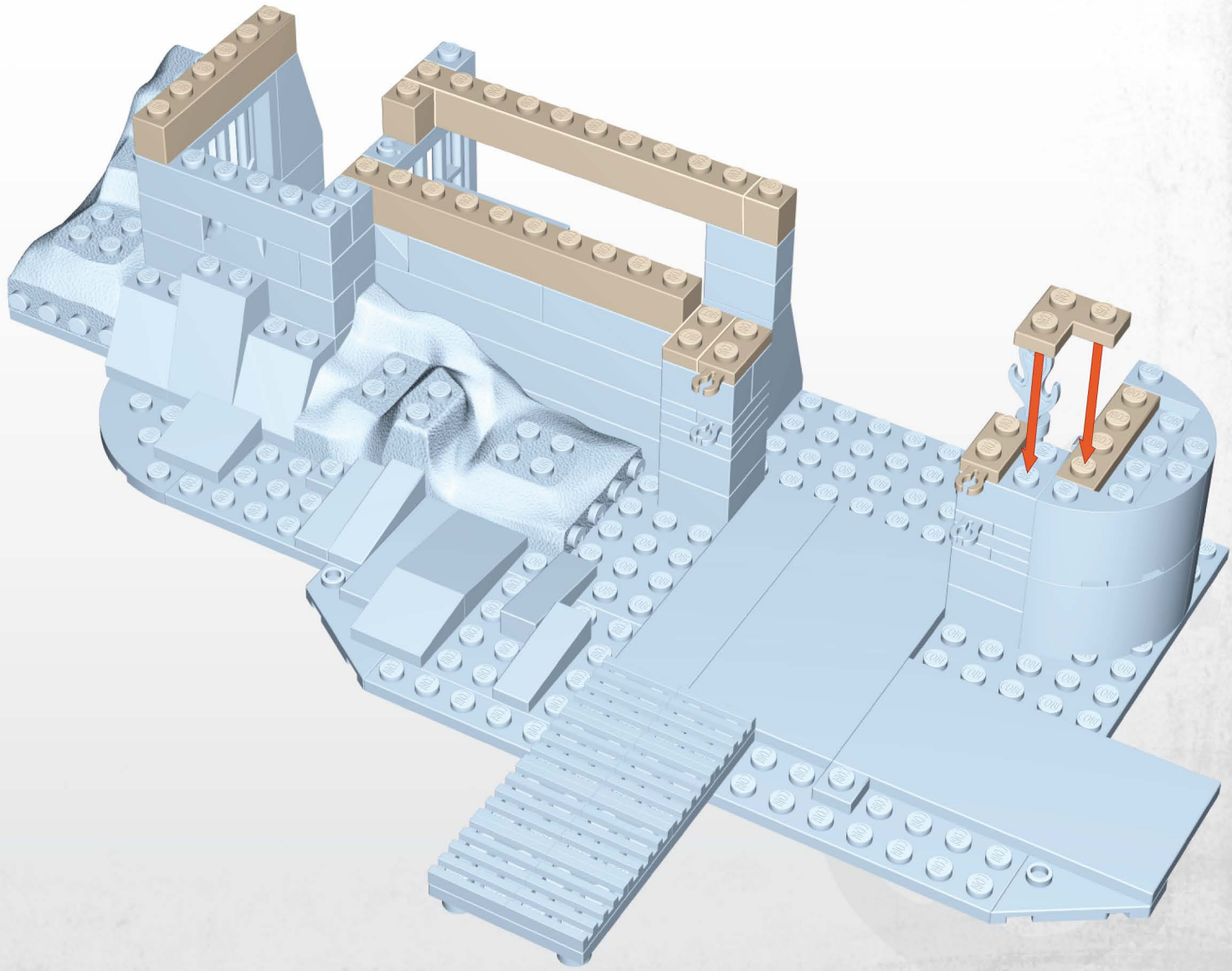



-  **x1**
-  **x2**
-  **x2**
-  **x1**
-  **x2**
-  **x1**
-  **x1**

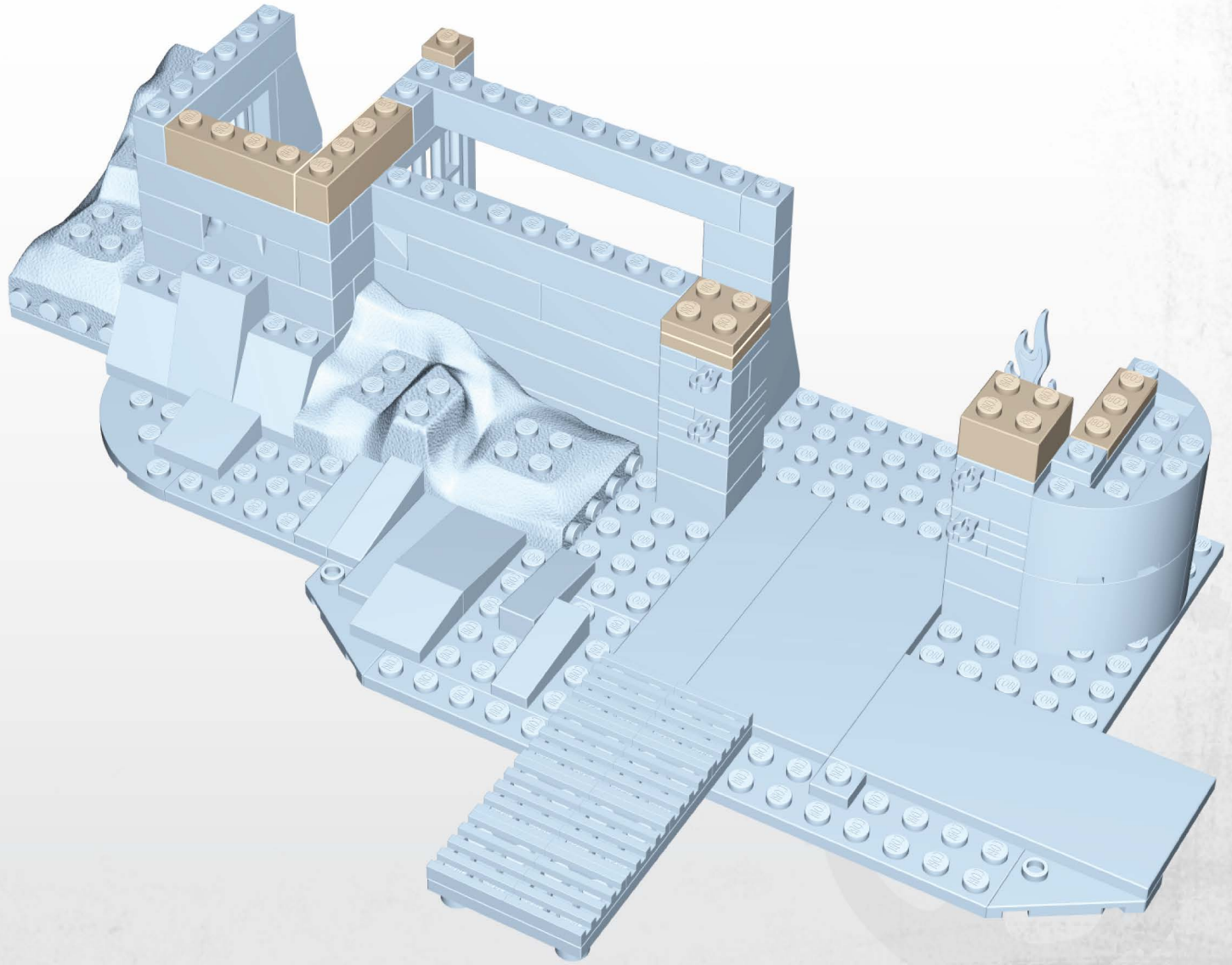





-  **x2**
-  **x1**
-  **x2**
-  **x1**
-  **x1**

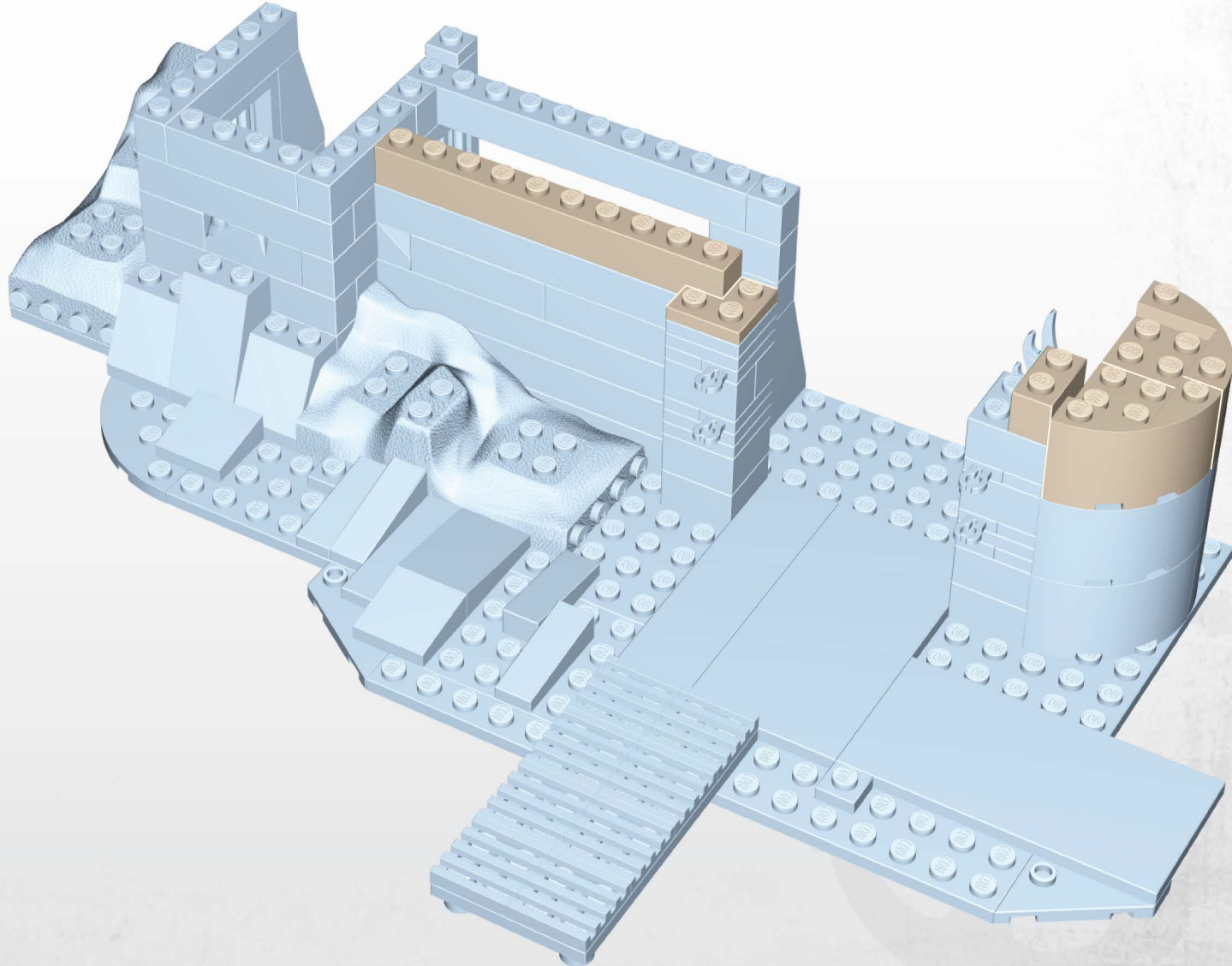







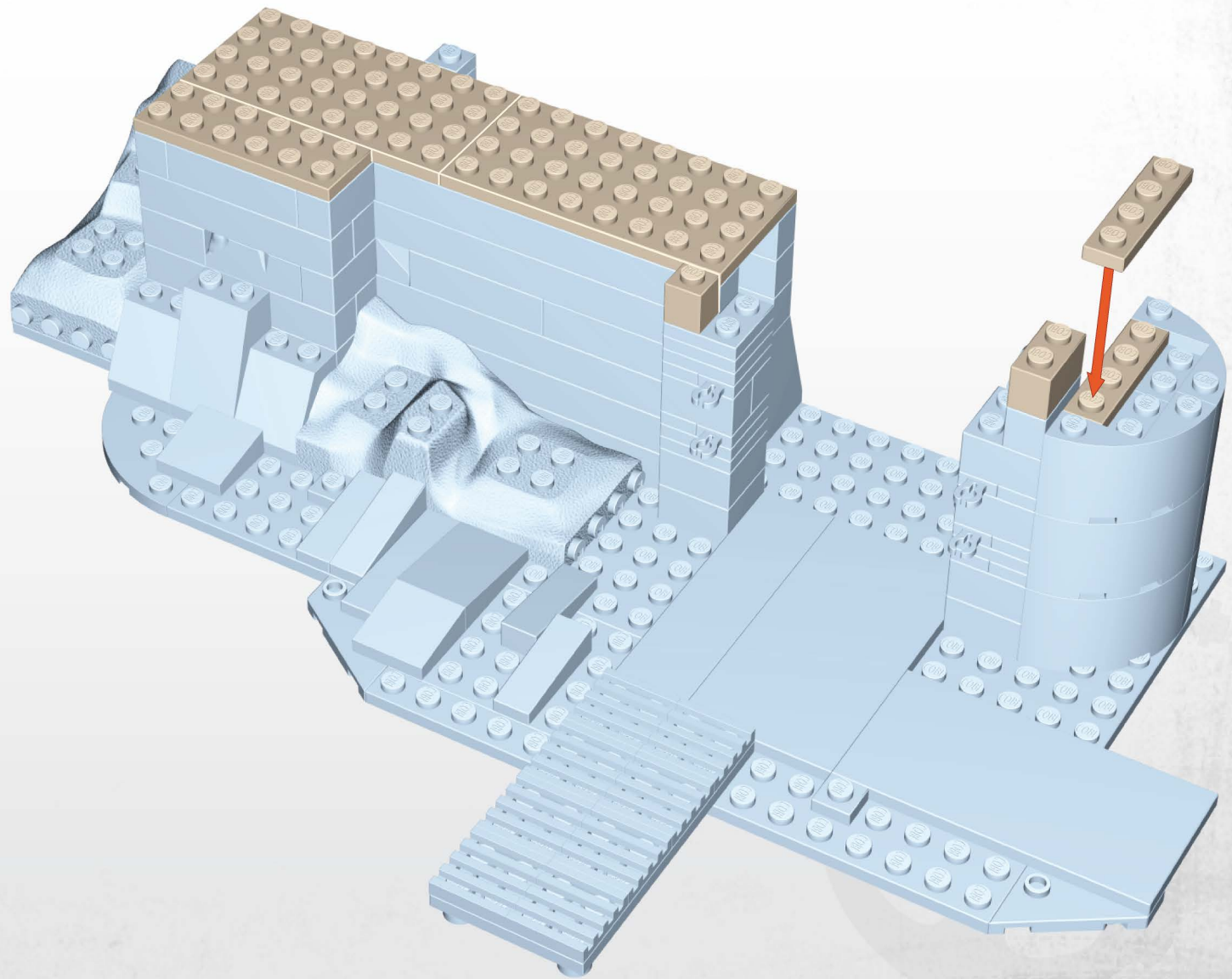

-  **x1**
-  **x1**
-  **x1**
-  **x2**

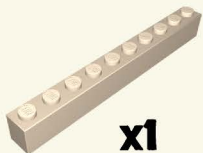

-  **x1**
-  **x2**
-  **x1**
-  **x1**
-  **x2**



-  **x2**
-  **x1**
-  **x1**
-  **x1**
-  **x1**
-  **x1**
-  **x2**
-  **x2**

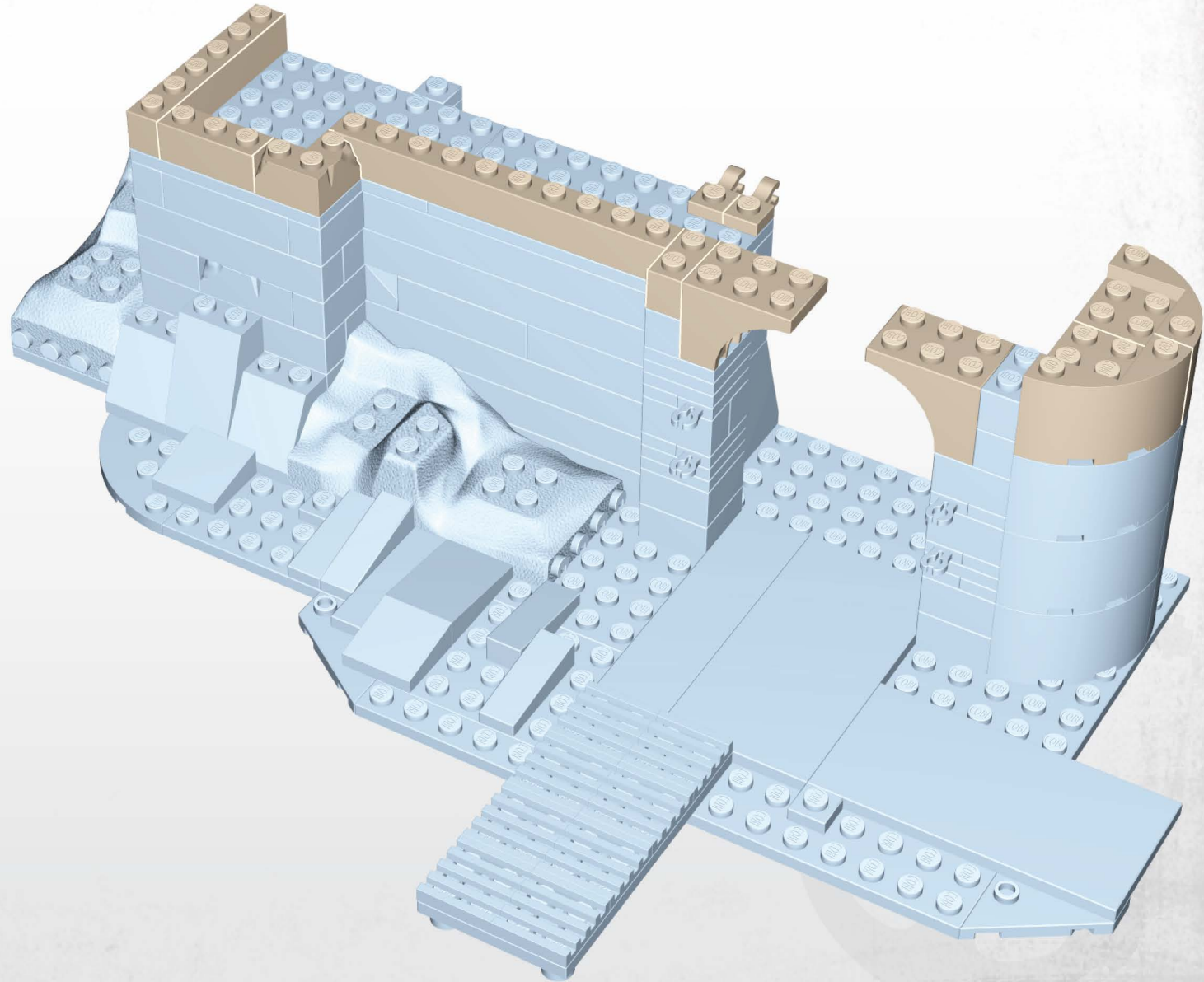

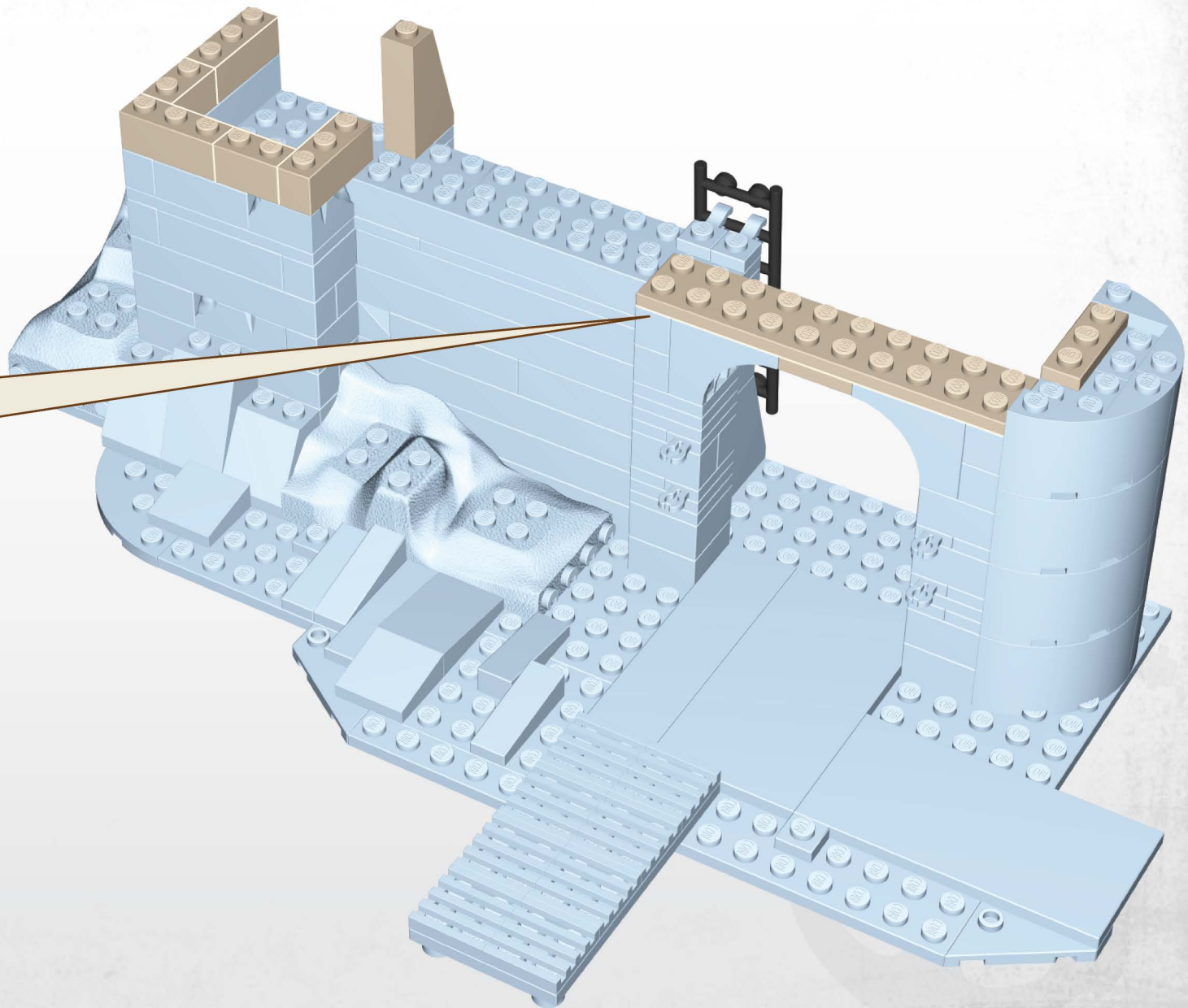
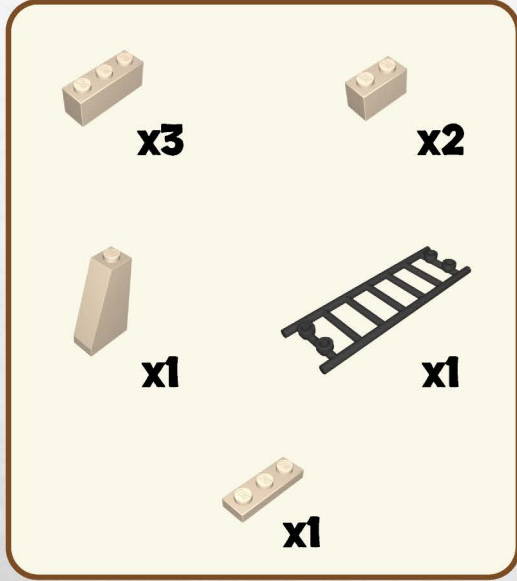
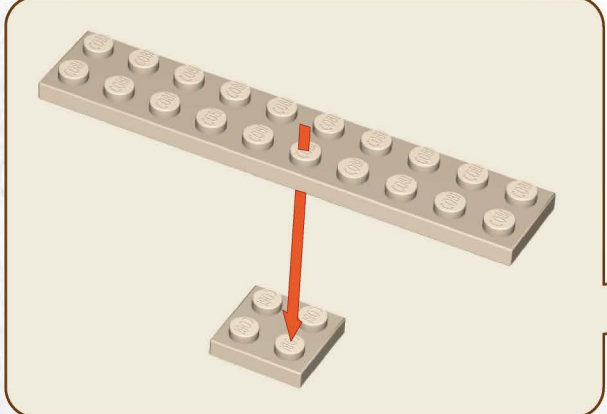
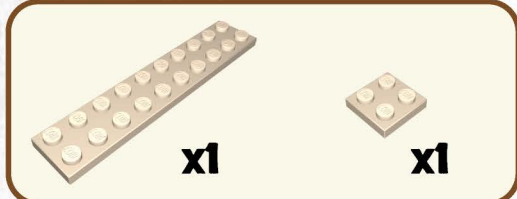





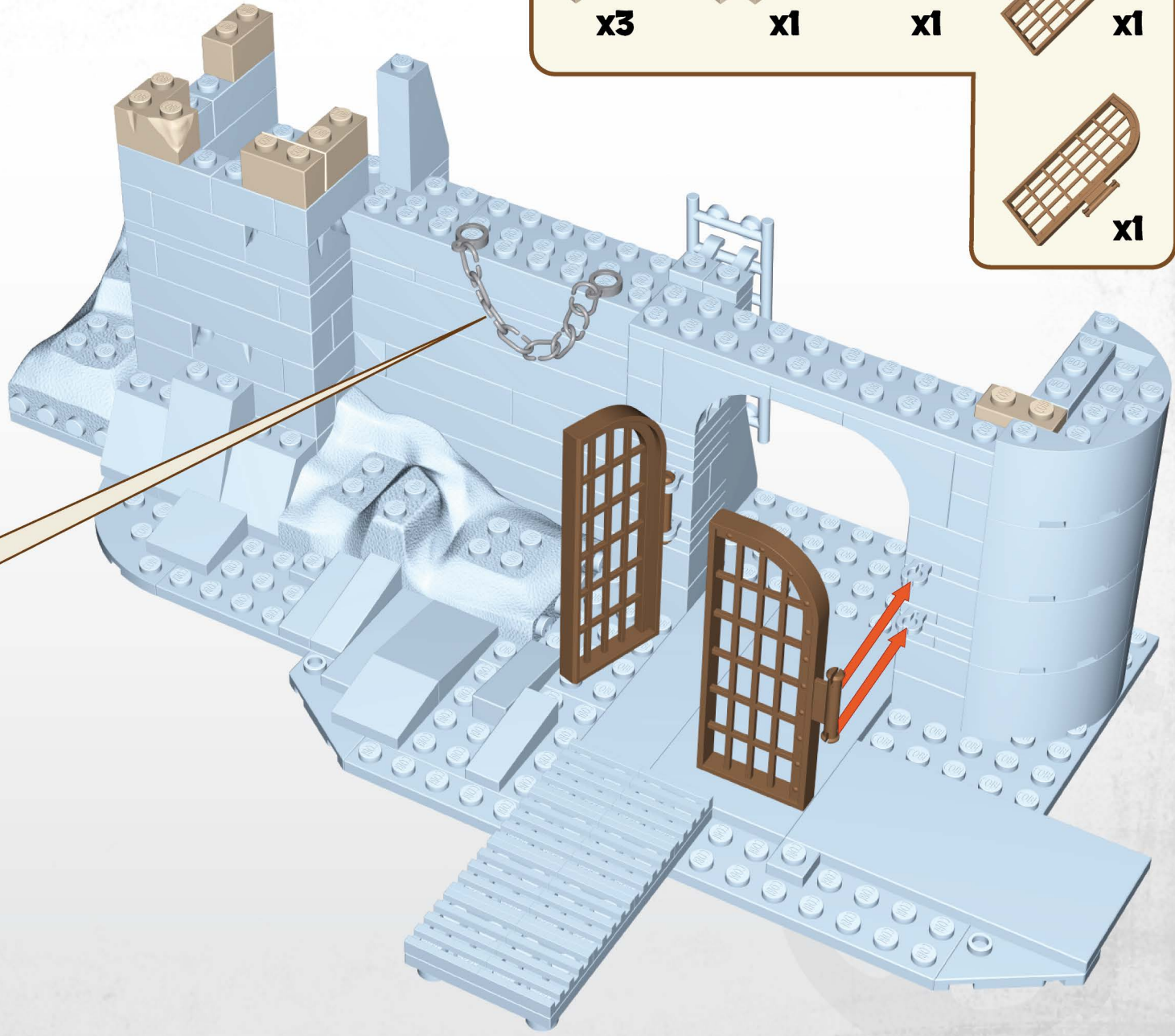

x3 x1 x1 x1





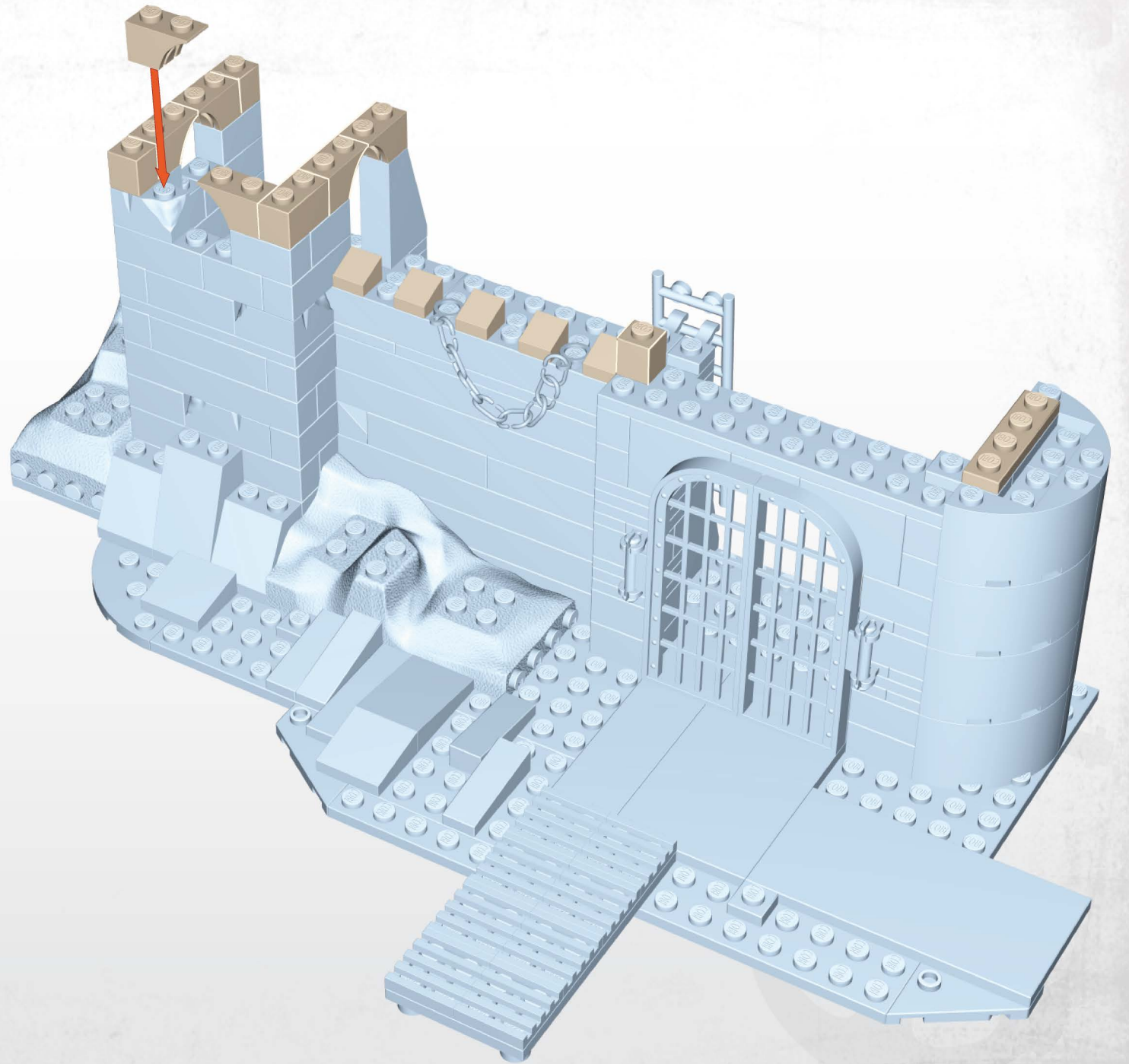

x1

x8 x2



-  **x3**
-  **x6**
-  **x1**
-  **x5**
-  **x1**



-  x2
-  x1
-  x1
-  x1
-  x1
-  x2

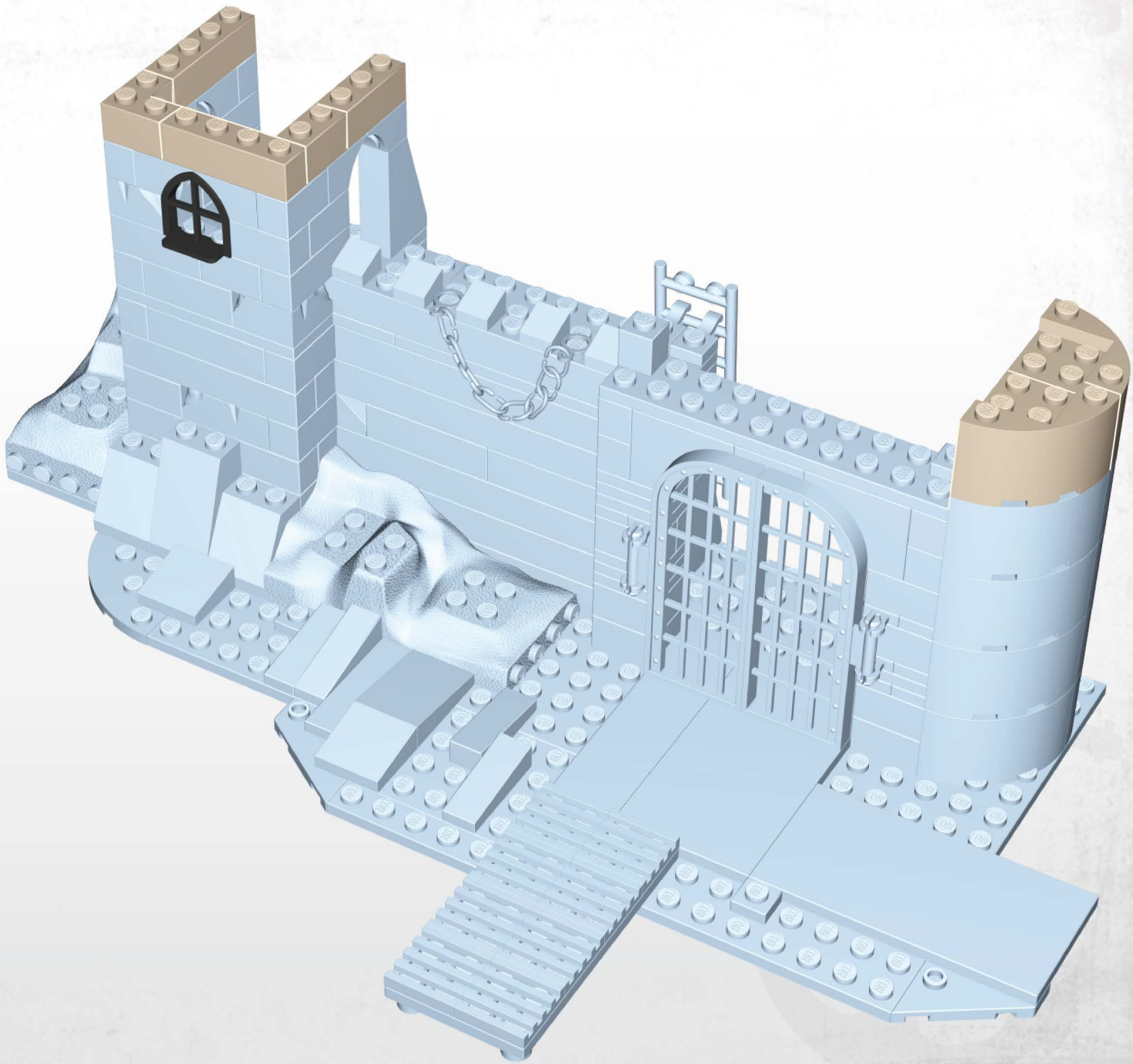

19

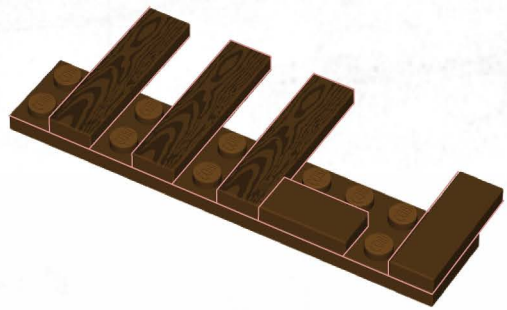

20

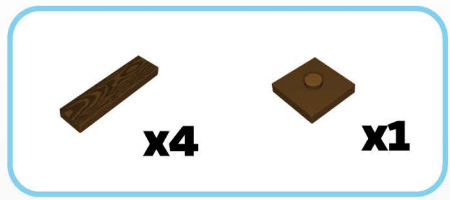
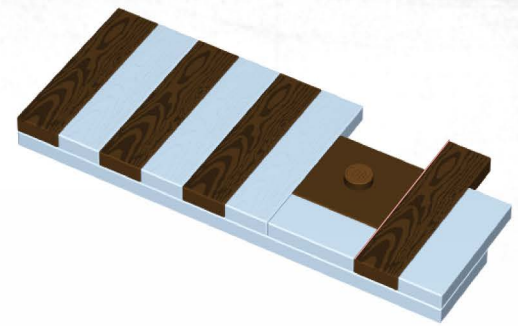

21

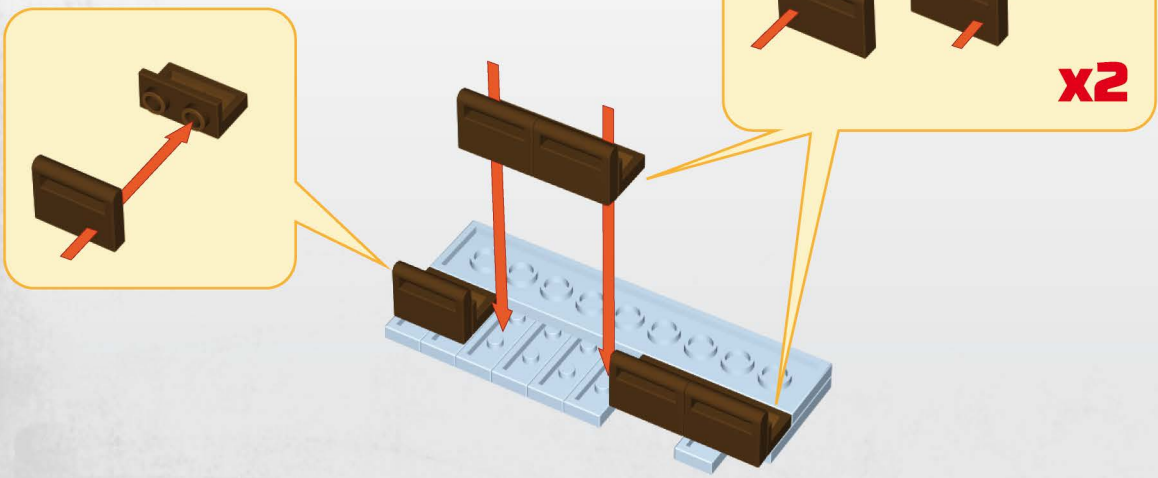

22

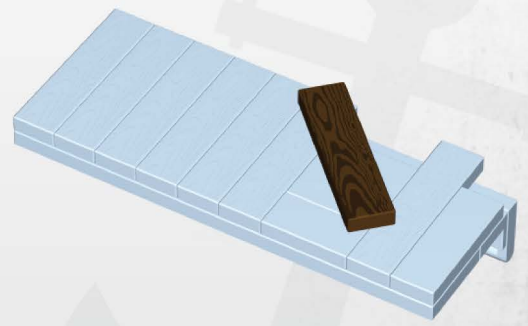

x6 x3





Diagram showing a dark brown 1x12 Technic plate being attached to a grey 1x12 Technic Technic brick with pins. Red arrows indicate the attachment points. A red circular arrow icon is below the diagram.

Diagram showing two grey 1x2 Technic Technic bricks being attached to a grey 1x4 Technic Technic brick with pins. Red arrows indicate the attachment points.

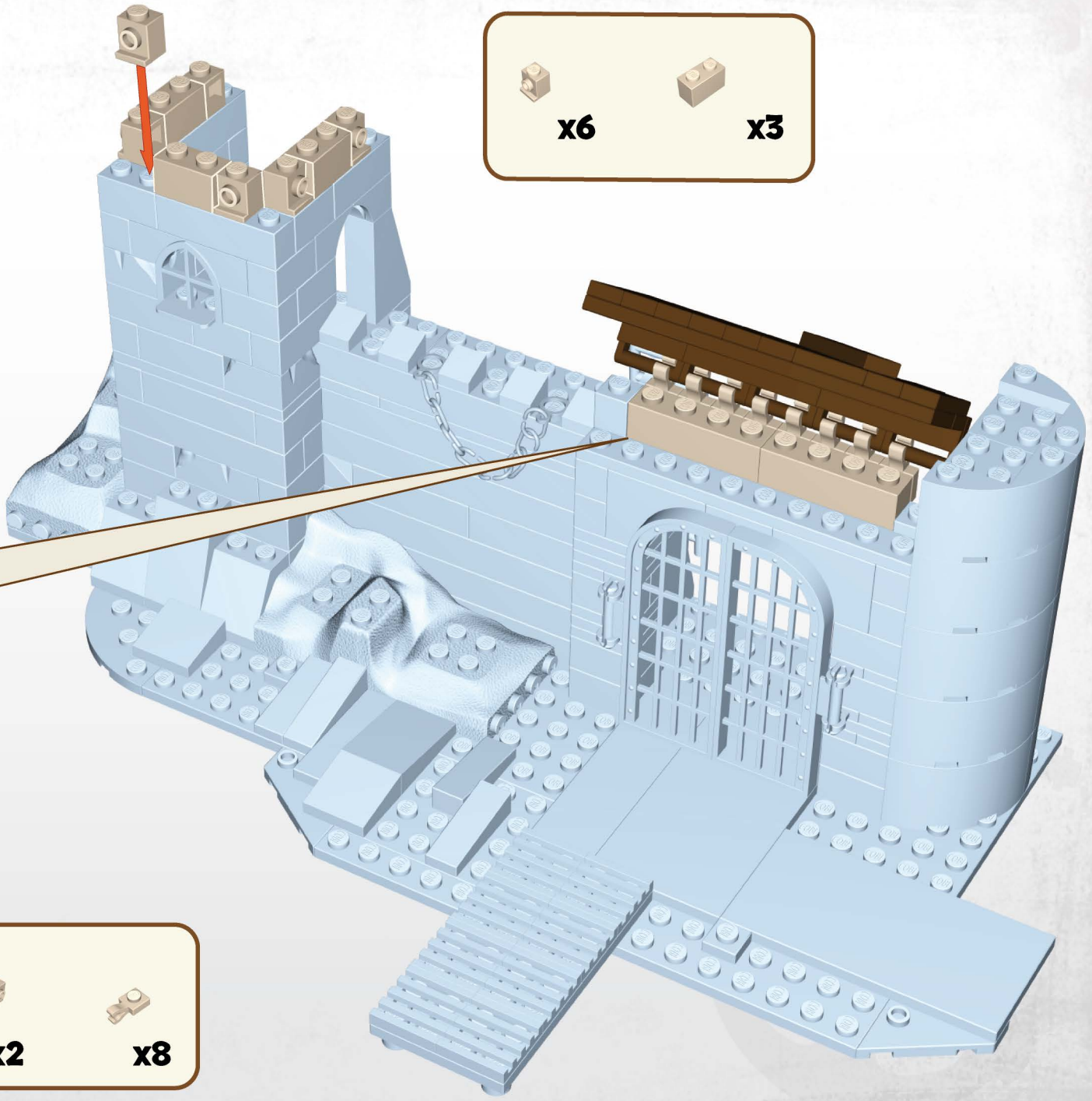
x2

x2 x8





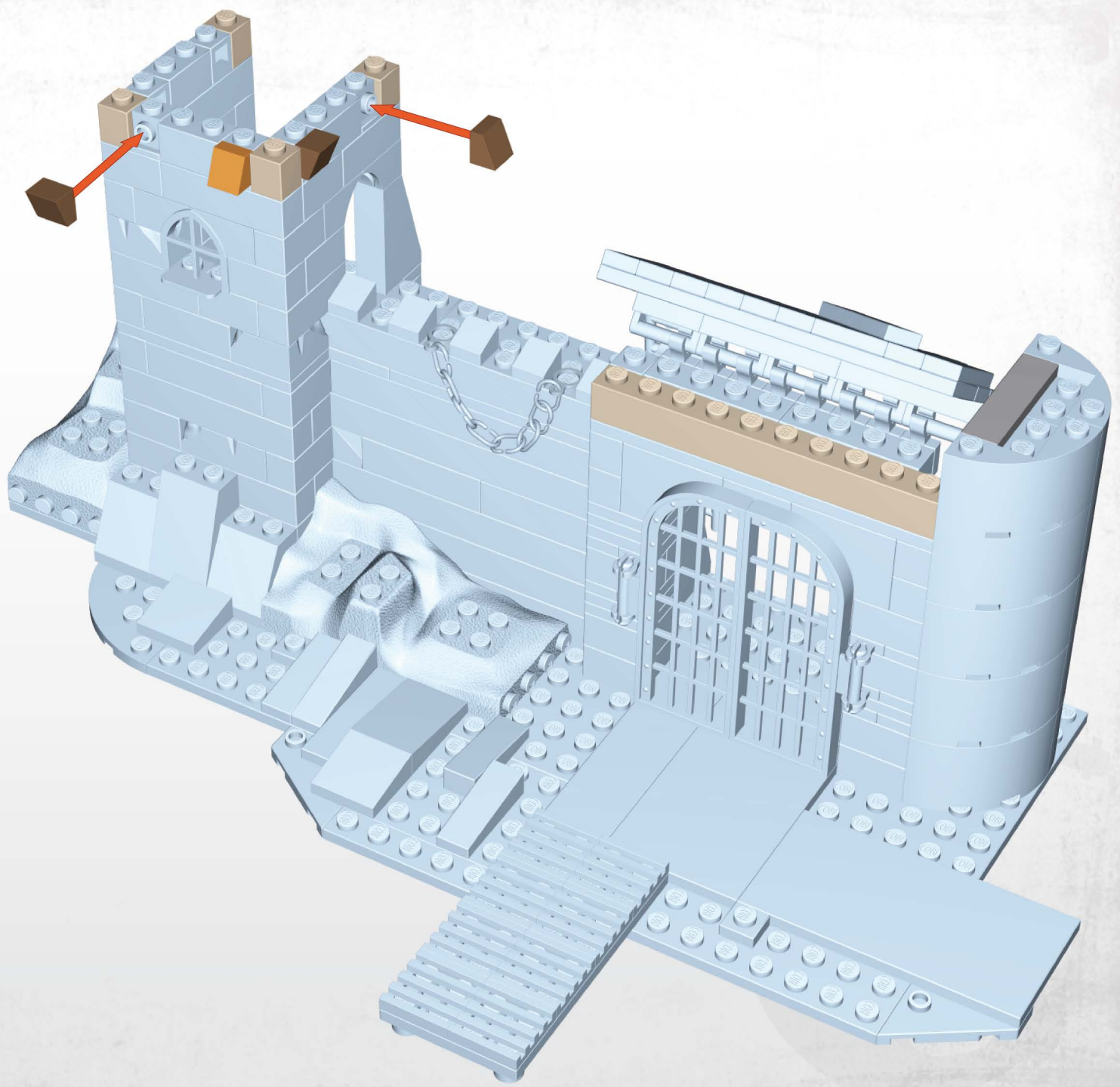

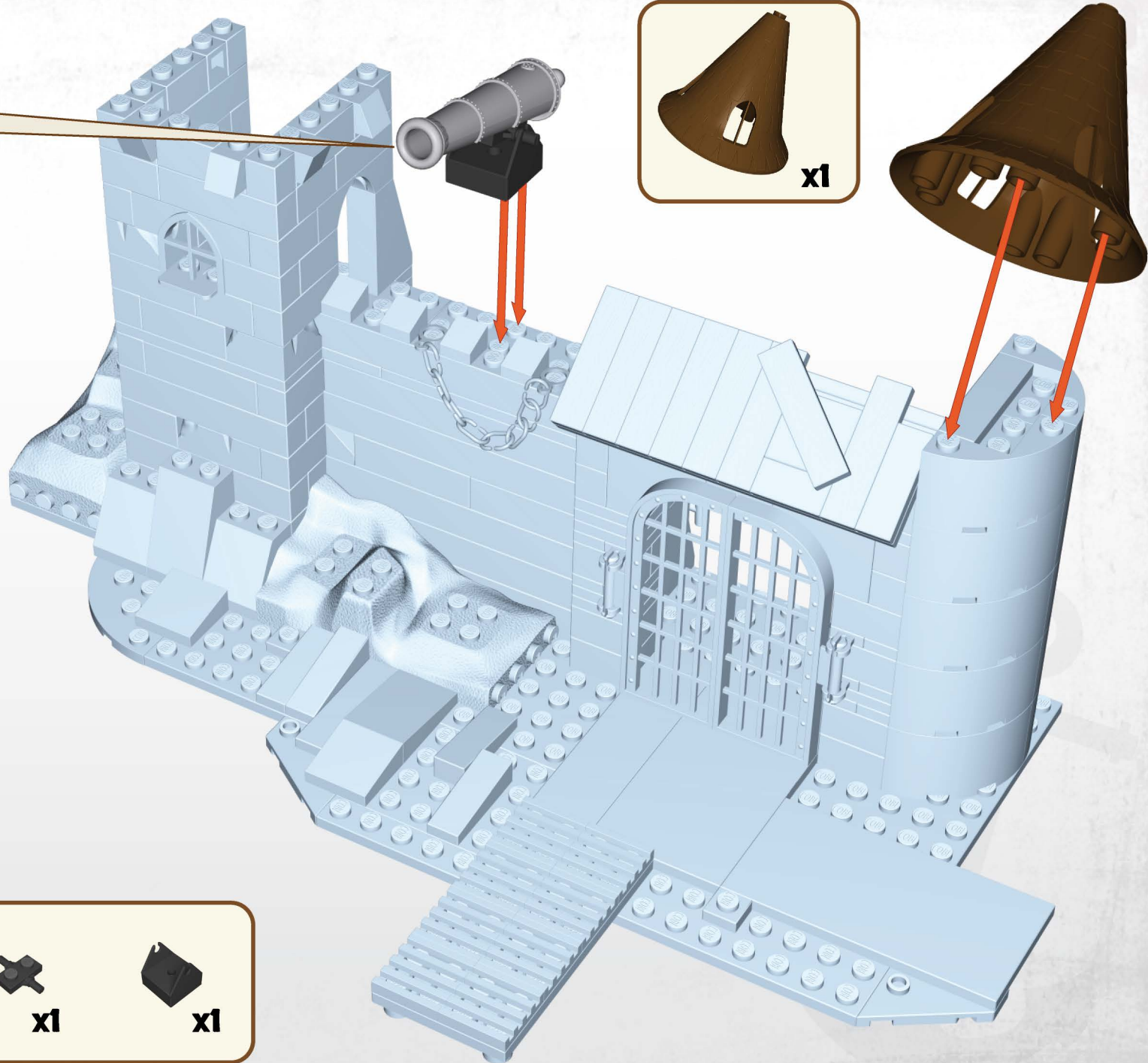
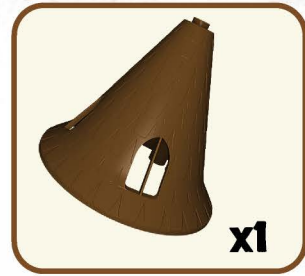
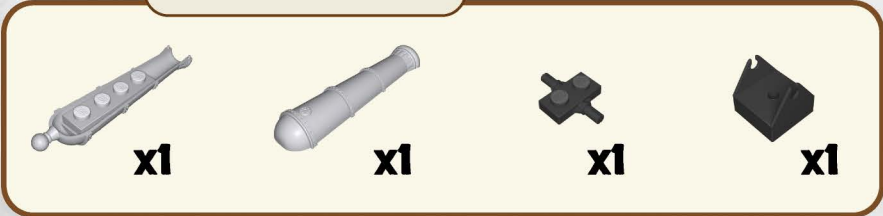
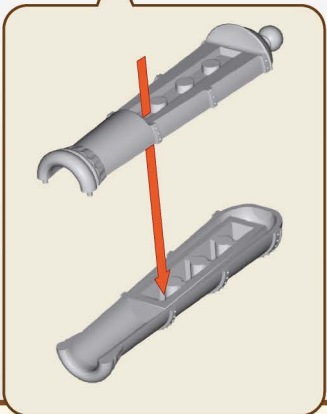
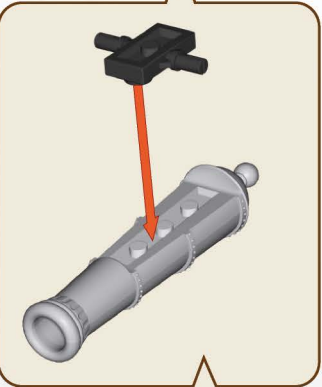
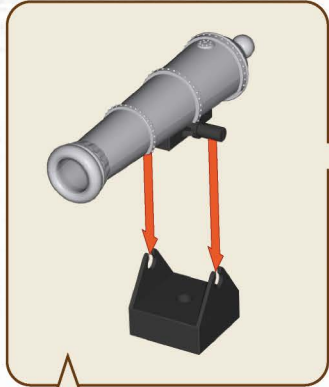
-  x4
-  x3
-  x1
-  x1
-  x1

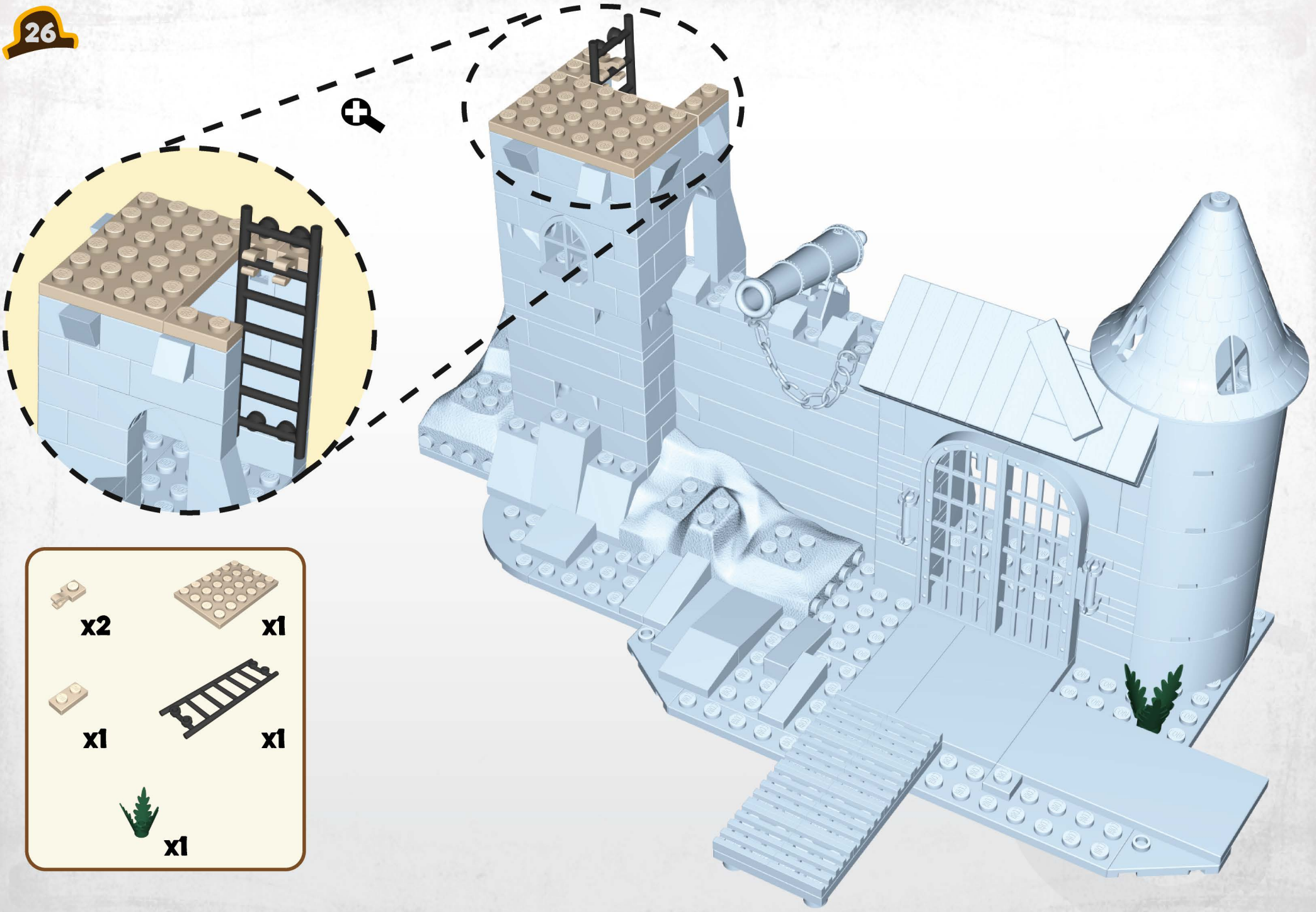



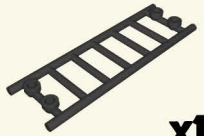

-  x2
-  x1
-  x1
-  x1
-  x1

27



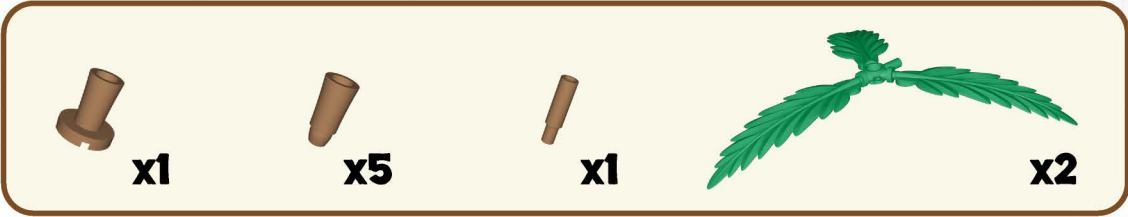
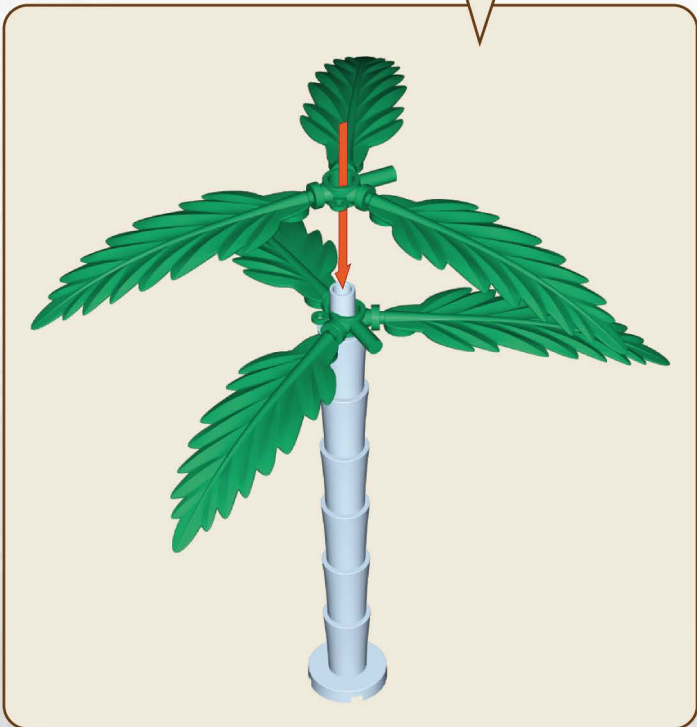
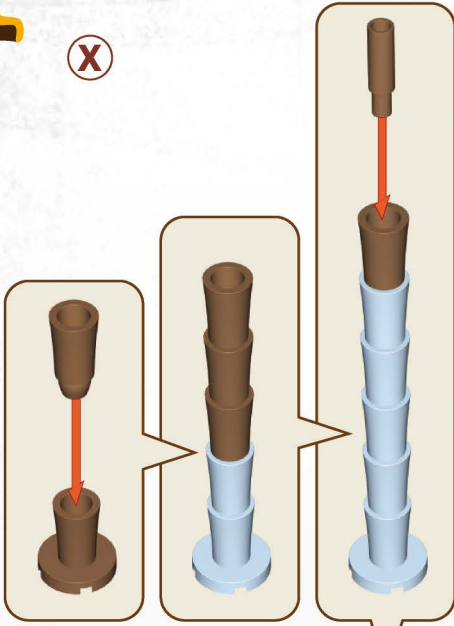

X

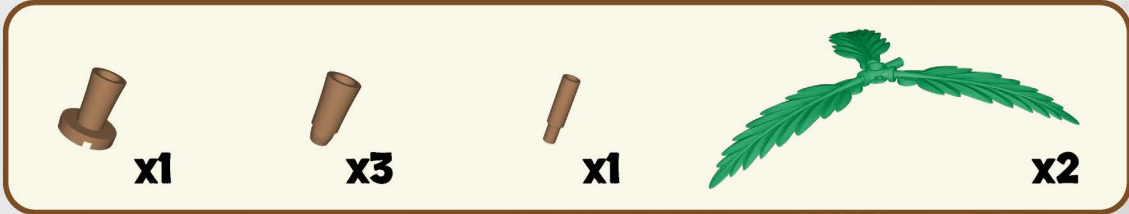
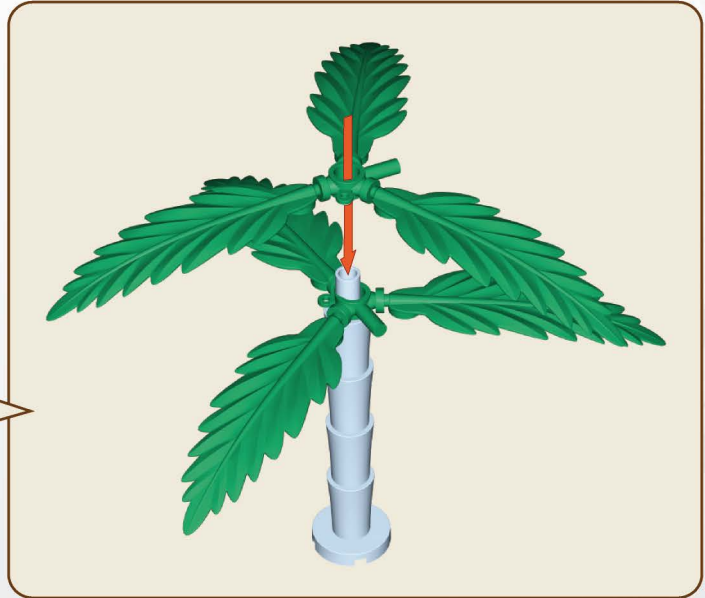
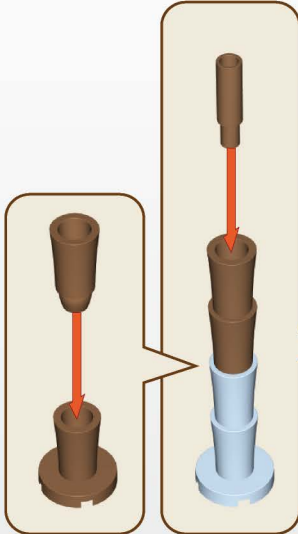

28

Y



-  x2
-  x1
-  x1
-  x1
-  x1

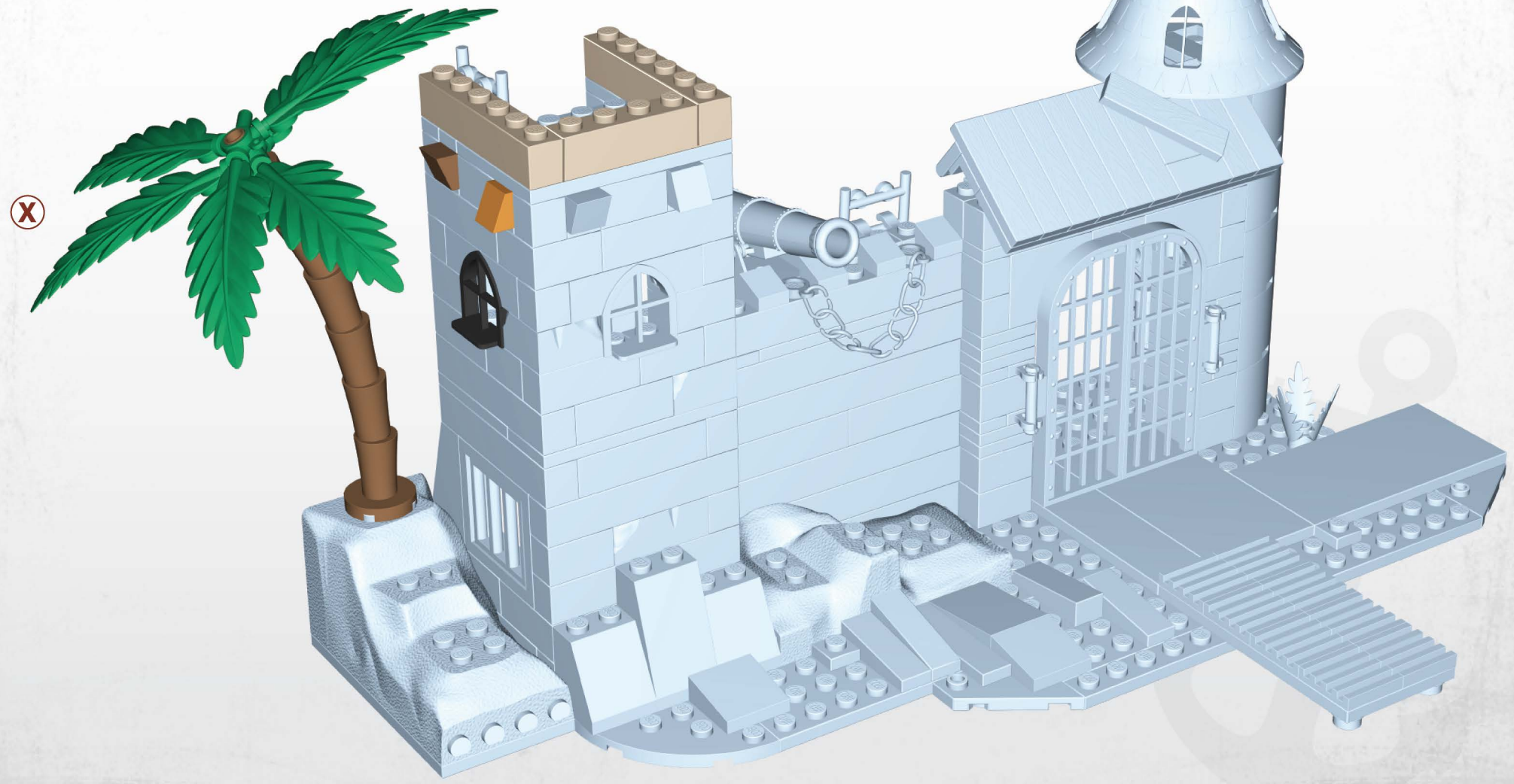

30



x4 x3



31

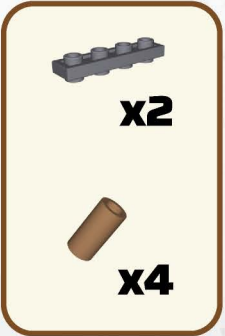
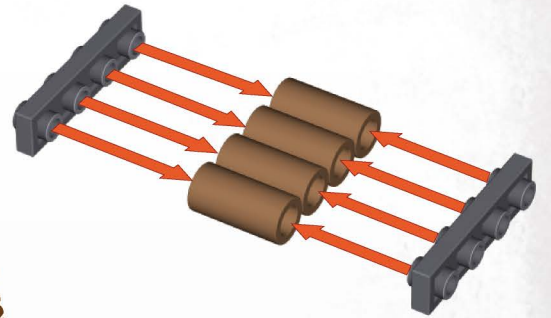

x2
x4

32

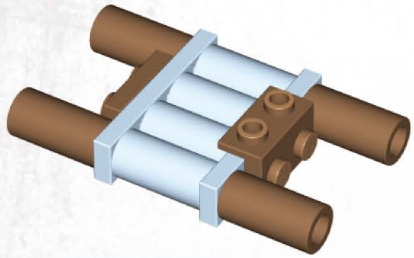

33

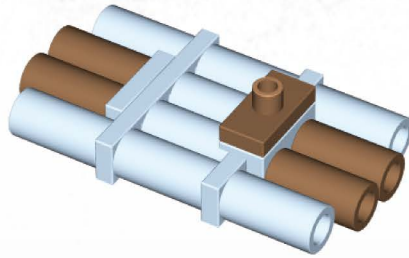

34

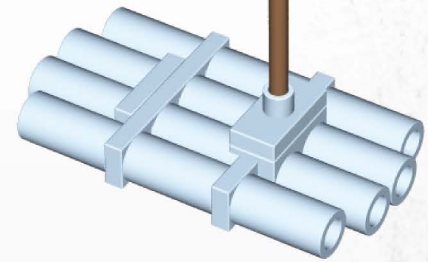
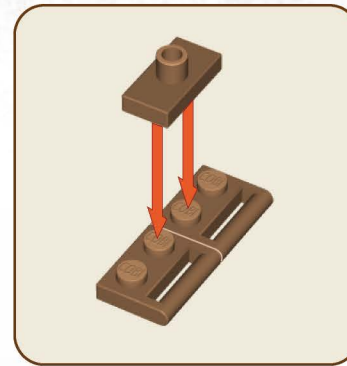

36

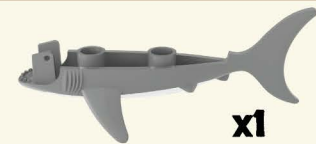
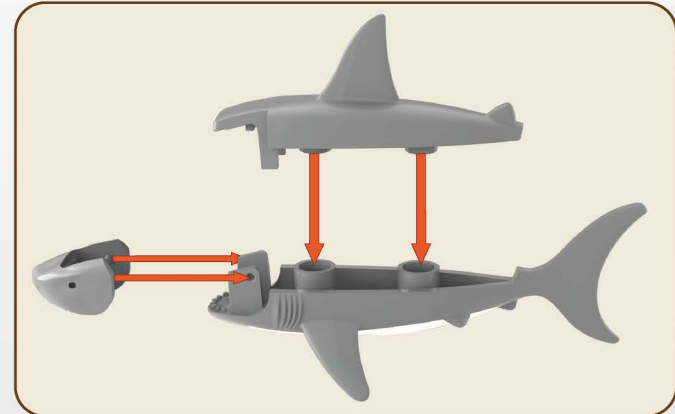

35

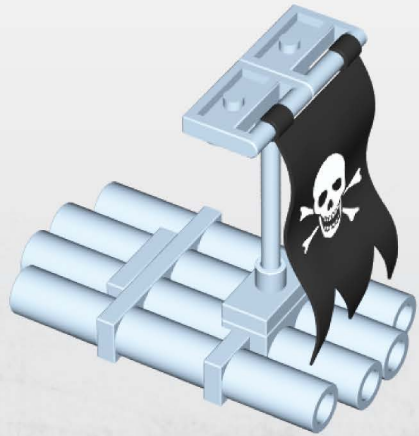

SMALL ARMY

Jeep, the Jeep grille and related logos, vehicle model names and trade dress are trademarks of FCA US LLC and used under license by Cobi.
©2017 FCA US LLC.

Jeep

scale 1:18



Jeep

WRANGLER
24260



The Pirate Bay
6014

Pirates



Castaway
6010



M1A2 ABRAMS
2608

GENERAL DYNAMICS LAND SYSTEMS inc.
This construction block set is produced under license from GDLS.



SKULL ISLAND
6012

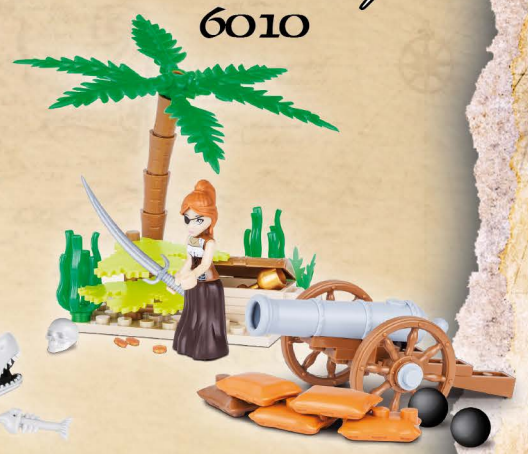

Buccaner Island
6011

12-06015-309

www.cobi.eu